



Invacare<sup>®</sup>

***Safe Patient Handling***

**Lifts  
Slings**

Trusted Solutions,  
Passionate People





## **Versatile and Safe**

### **An Ideal Solution for Residential and Nursing Care**

The *Invacare Roze Stand-Up Lifts* provide a safe, comfortable and mechanical assistance for people who have limited mobility and/or rehabilitation needs. Its premium features promote independence for the patient while relieving the lifting burden from the operator.

The *Invacare® Roze™ Stand Assist* offers an alternative to a passive lift when a degree of weight bearing ability remains. Ideal for rehabilitation, degenerative conditions and clients whose condition varies from day to day, the **Roze** can provide dignity and a greater degree of independence. With the latest control box technology, the **Roze** offers a 'Soft Start' and 'Soft Stop' function that provides a more comfortable transfer. Combining a range of adjustable features with a lightweight aluminum construction, the **Roze** is equally at home in Residential and Acute Care environments.

## Features and Options



### Height-adjustable leg support

The padded leg support can be adjusted for different needs.



### Removable foot plate

The foot plate is horizontal and can be removed for standing or walking a patient during rehabilitation.



### Control box with diagnostic system

This monitoring system includes a service reminder, emergency operation, audio battery alarm and battery indicator.

### A versatile stand assist









The *Invacare Roze* is a versatile stand assist lifter that supports the transfer of individuals who can only bear a minimal amount of their own weight. Ideal for transfers from a seated to seated or seated to standing position, the small footprint of the **Roze** and wide leg opening offers a flexible and comfortable transfer.

### Safety first, with an intelligent control box

The **Roze** is fitted with controls that highlight the battery status, indicates number of lifts, overloading information and service condition of the lifter to ensure safe patient handling.



## Technical Data

Lifting range	Inside width: legs opened	Outside width: legs closed	Overall length of base	Turning diameter	Height of legs	Battery	Total product weight
 37 - 63.4"	 44"	 26"	 38.8"	 54.3"	 4.0"	 24V DC Rechargeable	 117 lbs.

Invacare **Roze**

Max. user weight



Invacare **Roze**

450 lbs.

### Frame colours

Moderate white      Blue dusk



### Warranty

5 year warranty: Frame, control box, actuator

2 year warranty: Hand control

1 year warranty: Battery

\* The *Invacare Roze* is part of the Safe Patient Handling range.



TRUSTED SOLUTIONS, PASSIONATE PEOPLE



## Flexibility and Comfort

### An Ideal Solution for Acute and Residential Care

The **Jasmine** offers easy maneuverability and positioning for a wide range of lifts. With the latest control technology, **Jasmine** features a 'Soft Start' and 'Soft Stop' function, providing a more comfortable and dignified transfer. The **Invacare Jasmine Full Body Lift** has optimum functionality and innovative features that provide safer patient handling within a 500 lb. weight capacity.

The **Jasmine** lift expertly functions in more challenging situations with a rotating 360° 6-point hanger bar and 16.4" minimum height range, essential for assisting patients who may have fallen to the floor. The stable spring-loaded hanger bar produces an audible click when the sling is engaged. This assures the caregiver that the sling is properly attached. That means less stress for the caregiver, a stable transfer for the patient and a more comfortable experience for both.

## Safety First, with intelligent Controls

The **Jasmine** is fitted with a control system with integrated safety features. An intelligent service monitoring system highlights the battery status and service condition of the actuator to ensure the correct use and safety of the lift.

## Features and Options



### Spreader bar options

The **Jasmine** can be ordered with 2 or 4-point spreader bars. In widths: 17.7" and 21.7".



### Scale

A scale is available. Approved according to medical standard EN 45501, certified and sealed.



### Linak® Jumbo™ Care

The intelligent monitoring system includes a service reminder, emergency operation, audio battery alarm, and battery indicator.

## Flexibility and optimized maneuverability

The *Invacare Jasmine* is exceptionally mobile and easy to transport. The wide-opening base allows easy access for a wheelchair or armchair, whilst the high lifting mechanism is essential for transfers to and from elevated surfaces. Flexible and with optimised maneuverability, the **Jasmine** covers the needs of both the carer and client.

## Technical Data

	Overall length of base	Outside width: legs closed	Inside width: legs opened	Lifting range	Height of legs	Turning diameter	Max. user weight	Total product weight
<i>Invacare Jasmine</i>	49"	25.8"	46.7"	16.4" - 74.6"	4.0"	60.2"	500lbs.	98 lbs.

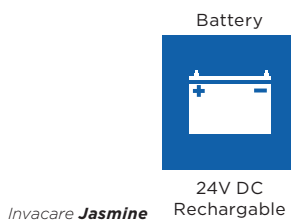

### Frame colours

White

Blue dusk



### Warranty

5 year warranty:  
Frame, control box,  
actuator

2 year warranty:  
Hand control

1 year warranty:  
Battery

\* The *Invacare Jasmine* is part of the Safe Patient Handling range.



TRUSTED SOLUTIONS, PASSIONATE PEOPLE



Reliant 450  
Mobile Lift



Reliant 350  
Stand Assist Lift



Reliant 600  
Mobile Lift

## Adaptable and Reliable

### For Safe and Comfortable, Seated to Seated Transfers

The *Invacare Reliant Series Lifts* are an ideal product for everyday patient handling, ensuring caregiver security and patient peace of mind during the transfer. Intended for use with weight-bearing patients as well as those needing rehabilitation support, the *Invacare Reliant Stand-Up Lift* will be a valuable addition to your safety management system.

# Reliant™ 350 Stand Assist Lift

The *Invacare® Reliant™ 350 Stand Assist* is a compact and manoeuvrable mobile lifter that provides safe and comfortable assisted transfers for those with limited mobility or rehabilitation needs. The *Invacare Reliant 350* can be used to transfer a client that cannot transfer unaided, but has some level of weight bearing ability, from one seated position to another. The robust design with a safe working load of 350 lbs allows for additional support whilst transferring, preventing unnecessary strain, making it an ideal option for transfers carried out by a single caregiver.

## Features and Options



### Independent Charger

An off-board charger and spare battery allow for 24 hour use.

Please note: The battery cannot be charged on the lift.

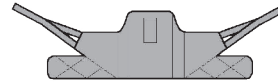

### Stand Assist Sling

Designed for **Stand Assist** lifters, this sling features the latest innovative fabric for improved comfort and handling.

Available in sizes S, M, L & XL

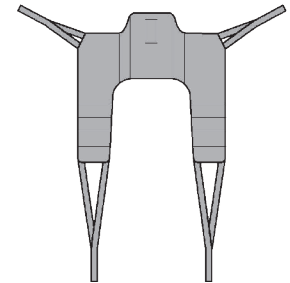

### Transfer Stand Assist Sling

Designed for **Stand Assist** lifters, for those who require additional leg support, this sling provides a supportive and comfortable transfer.

Available in sizes S, M, L & XL

## Adaptable and Easy to Use









**Reliant 350** features a multi-adjustable lift boom and a selection of sling mounting positions to provide an adjustable and ergonomic lift angle. Large rear and small front casters help manoeuvre the **Reliant 350** into small or confined spaces, while the base has a lever adjustment mechanism for added stability. In addition, the generous non slip footplate provides a stable surface and height-adjustable padded knee guard.

## Safe and Reliable

The **Reliant 350** provides a range of safety features including an emergency stop button, emergency manual descent system, as well as an anti-entrapment device which stops the boom from lowering if it meets resistance. The battery recharge indicator is visual and audible. For transport and storage, the **Reliant 350** can be easily dismantled.

## Technical Data

For more comprehensive pre-sales information about this product, including the product's user manual, please visit [www.invacare.ca](http://www.invacare.ca)

Max. height	Min. height	Overall length of base	Inside width: legs opened	Outside width: legs closed	Height of legs	Number of cycles	Total product weight
 63.7"	 39.6"	 35.4"	 36.8"	 25.7"	 3" Front 5" Rear	 100 - 200 lifts per full charge	 115 lbs.

Invacare  
**Reliant 350**

Max. user weight



350 lbs

Invacare  
**Reliant 350**

### Frame colour

Beige



### Warranty

1 year - Motor

3 years - Lift

\* The *Invacare Reliant 350 Stand Assist* is part of the Safe Patient Handling range.



TRUSTED SOLUTIONS, PASSIONATE PEOPLE

# Reliant™ 450 Mobile Lift

The **Reliant™ 450 Lift** features a Swivel bar with double loop aluminum clips and wrapped cover for safe operation, Ergonomic push bar accommodates a range of caregiver heights, Battery life indicator, emergency up/down, and low battery alarm, Includes a spare 24V battery and a remote charging station to minimize downtime, Foldable design delivers added convenience for easy storage or travel.

## Features and Options



### Independent Charger

An off-board charger and spare battery allow for 24 hour use.

Please note: The battery cannot be charged on the hoist.



### Rear Locking Brakes

Locking feature on 5" rear casters is standard on all models.



### Hand Pendant

Ergonomic control with heavy-duty cord. Convenient pendant hook allows attachment and storage on multiple areas of lift.



### Invacare Reliant Digital Scale







Retrofits on all **Reliant 450/600 Lifts** swivel Bar. Easy to operate and four-button display provides digital weight reading. Automatic shut-off feature prolongs battery life. Two-year limited Warranty.

### Safe and Reliable

The **Reliant 450** provides a range of safety features including an emergency stop button, emergency manual descent system, as well as an anti-entrapment device which stops the boom from lowering if it meets resistance. The battery recharge indicator is visual and audible. For transport and storage, the **Reliant 450** can be easily dismantled.

## Technical Data

For more comprehensive pre-sales information about this product, including the product's user manual, please visit [www.invacare.ca](http://www.invacare.ca)

Max. height	Min. height	Overall length of base	Inside width: legs opened	Outside width: legs closed	Height of legs	Total product weight
 71"	 25"	 48"	 41"	 26.5"	 3" Front 5" Rear	 93 lbs.

Invacare  
Reliant 450

Max. user weight
 450 lbs

Invacare  
Reliant 450

### Frame colour

Beige



### Warranty

1 year - Motor  
3 years - Lift

\* The **Invacare Reliant 450 Stand Assist** is part of the Safe Patient Handling range.



# Reliant™ 600 Mobile Lift

Designed to meet the special needs of your patients weighing up to 600 lb., the *Invacare® Reliant™ 600 Heavy-Duty Lift* is secure and sturdy, providing a safe alternative to manual lifting. Both durable and functional, the *Reliant 600 Lift* is also a reassuring and comfortable patient lift. When answering the needs of every patient is your priority, this is your wisest choice.

## Features and Options



### Independent Charger

An off-board charger and spare battery allow for 24 hour use. Please note: The battery cannot be charged on the lift.



### Manual Lowering

Manual emergency lowering gently and safely lowers the patient in case of total power loss. Essential safety feature.



### Hand Pendant

Ergonomic control with heavy-duty Cord. Convenient pendant hook allows attachment and storage on multiple areas of lift.



### Rear Locking Casters

Locking feature on 5" rear casters is standard on all models.

## Safe and Reliable

The *Reliant 600* provides a range of safety features including an emergency stop button, emergency manual descent system, as well as an anti-entrapment device which stops the boom from lowering if it meets resistance. The battery recharge indicator is visual and audible. For transport and storage, the *Reliant 600* can be easily dismantled.

## Technical Data

For more comprehensive pre-sales information about this product, including the product's user manual, please visit [www.invacare.ca](http://www.invacare.ca)

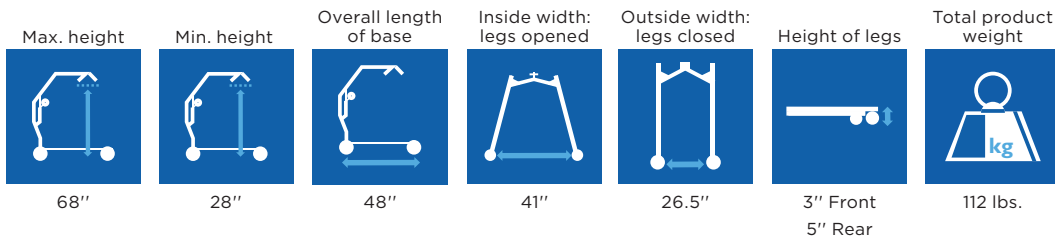

Invacare  
**Reliant 600**



Invacare  
**Reliant 600**

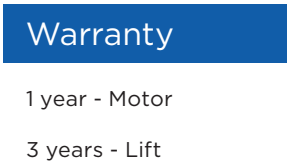
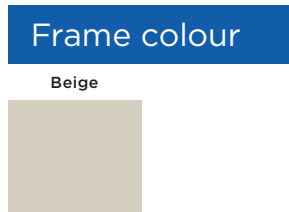

\* The *Invacare Reliant 600 Heavy Duty Lift* is part of the Safe Patient Handling range.



TRUSTED SOLUTIONS, PASSIONATE PEOPLE



## Optimal Positioning and Ease of Application

The *Invacare Premier Series Slings* balance solutions for any transfer. *Invacare* says this with confidence because these slings were developed in collaboration with Occupational and Physical therapists. *Invacare Premier Slings* are available in a wide variety of styles and can be adjusted to ensure a comfortable and secure fit for the patient. Clearly labeled slings and easy attachment points make it simple for the caregiver to quickly attach the sling and lift the patient.

## Invacare® Slings

Invacare's range of slings provides a safe and comfortable transfer solution for many types of physical disability. This selection of high quality slings has been developed with the collaboration of Occupational Therapists, to ensure optimal fit, support for the client and ease of application for the carer. Most slings are available in five sizes with the option of fabric type. A range of adjustments enable the slings to meet the specific needs of each individual.



### Invacare **Universal High Sling**

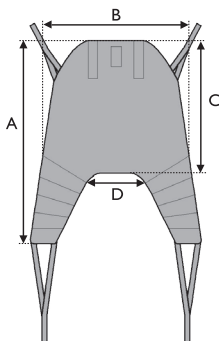

Supports the upper body, head and neck, giving the client a comfortable and slightly reclined position. The **Universal High Sling** is typically used for those who have limited control of the head, trunk or hips – or for transfers to and from a lying position. The **Universal High Sling** can also be used for seated to seated transfers. This sling can also be used without the head support, by simply removing the plastic rigidisers.

Size	A	B	C	D	Model # / Material	
					Polyester Fabric	Spacer Fabric
S	42.6"	33.1"	28.8"	15.0"	2483777	2485956
M	55.9"	39.4"	32.7"	15.8"	2483778	2485957
L	61.1"	43.3"	36.2"	20.1"	2483779	2485958
XL	66.2"	45.3"	36.2"	21.7"	2485949	2485959

### Invacare **Universal High Plus Sling**

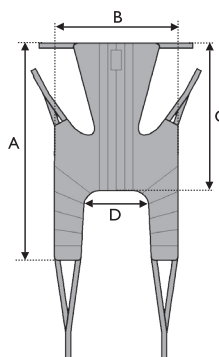

Supports the upper body, head and neck, giving the client a comfortable and slightly reclined position. The **Universal High Plus Sling** also allows clients to keep their arms outside the sling. It is typically used for those who have limited control of the head, trunk or hips – or for transfers to and from a lying position. The **Universal High Sling** can also be used for seated to seated transfers. This model has a stiffened fabric in the back section, to ensure optimal weight distribution and comfort for the client.

Size	A	B	C	D	Model # / Material
					Polyester Fabric
S	54.4"	33.1"	34.7"	13.4"	2485960
M	59.5"	37.4"	36.6"	17.7"	2485961
L	62.3"	43.3"	38.2"	22.1"	2485962
XL	62.6"	46.9"	38.2"	24.8"	2485963



TRUSTED SOLUTIONS, PASSIONATE PEOPLE

## Invacare® Dress Toileting Sling

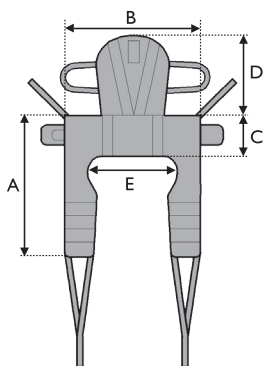

The **Dress Toileting Sling** is suitable for those with limited mobility. The model with head support is designed for clients who also have reduced head control. The **Dress Toileting Sling** is suitable for those who want to be able to dress and undress during the toilet transfer. It is used for seated to seated transfers and is very easy to apply.

	Model # / Material				
Size	A	B	C	D	Polyester Fabric
<b>S</b>	34.3"	28.0"	7.9"	16.9"	2478444
<b>M</b>	34.7"	31.5"	9.1"	19.3"	2478445
<b>L</b>	40.2"	35.5"	9.1"	23.6"	2478446
<b>XL</b>	43.3"	42.6"	10.6"	29.9"	2484780

## Invacare Easy-fit Sling

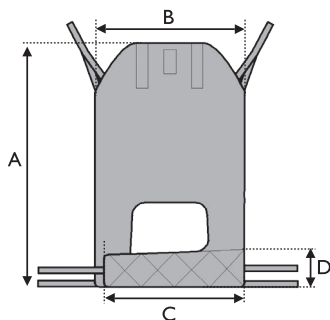

Supports legs and thighs in various combinations and is therefore suited for clients with the most challenging physical disabilities. The specially designed separate leg supports are easy to apply, and the sling affords a good hip position, allowing the client to sit relatively upright while supporting the head and neck. The **Easy-fit Sling** is also well-suited for amputees. It is easy to apply in both sitting and lying positions.

	Model # / Material				
Size	A	B	C	D	Polyester Fabric
<b>S</b>	44.5"	29.9"	25.2"	7.1"	2451102
<b>M</b>	47.3"	31.5"	26.6"	7.5"	2451103
<b>L</b>	50.0"	33.9"	28.4"	8.3"	2451104
<b>XL</b>	54.8"	37.0"	30.7"	8.7"	2451105

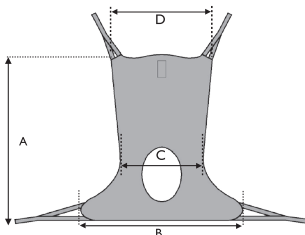
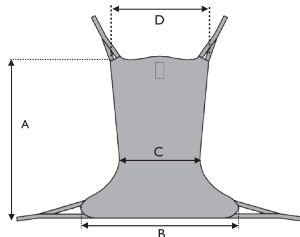

The **Comfort Sling** is the traditional full body sling with added comfort features.

This sling model is available in two versions, the **Comfort Sling** and **Comfort Toileting Sling**. The **Comfort Toileting Sling** is applied the same way and used for toileting.

The **Comfort Sling** supports the whole body and is ideally suited to those with chronic pain. The sling is also useful for above-knee amputees or for those, who due to postural position or pain, prefer to remain in a seated position.

The **Comfort Sling** can be applied while the client is lying down and used to transfer the individual into a seated position.

Size	A	B	C	D	Model # / Material		
					Net Fabric	Polyester Fabric	Net Fabric
<b>S</b>	45.3"	41.4"	21.7"	40.2"	2485968	2451092	2451097
<b>M</b>	55.2"	46.1"	24.0"	46.5"	2485969	2451093	2451098
<b>L</b>	57.1"	50.8"	26.4"	50.4"	2485970	2451094	2451099
<b>XL</b>	57.5"	52.4"	29.6"	57.9"	2485947	2451095	2451100

Invacare® **Stand Assist Sling**



Designed for use with the **Roze** and **Reliant 350** lifter, but compatible with other types of Stand Assist lifter\*. The *Invacare Stand Assist Sling* offers a comfortable and safe transfer for clients who have some weight bearing ability, but cannot stand independently. In addition, the client should be coherent, have good body and head control and the ability to grip the lift boom during the transfer. The sling is well padded and comes with non-slip material on the back to ensure a comfortable transfer position.

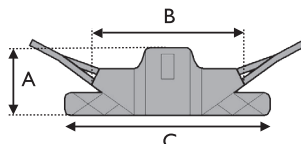

	Model # / Material			
Size	A	B	C	Polyester Fabric
S	10.2"	33.1"	34.7"	2484685
M	13.0"	35.3"	46.1"	2484686
L	14.2"	37.4"	50.0"	2484687
XL	14.2"	40.2"	71.3"	2484688

Invacare **Transfer Stand Assist Sling**



The *Invacare Transfer Stand Assist Sling* can be used with the **Roze** and **Reliant 350** lifter and enables a simple seated transfer. This sling is used for those with good body and head control who are able to grip the lift boom.

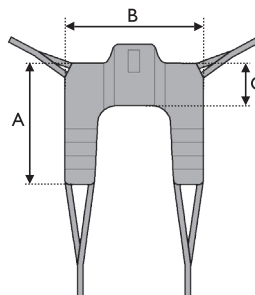

	Model # / Material			
Size	A	B	C	Polyester Fabric
S	33.9"	33.1"	9.5"	2484689
M	40.2"	35.3"	10.2"	2484690
L	46.5"	37.4"	13.0"	2484691
XL	48.5"	40.2"	13.8"	2485117

## Fabrics

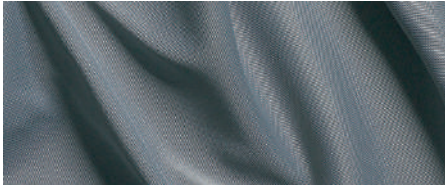

### Solid Polyester

A standard material that is easy to apply - slides smoothly and dries quickly after washing.

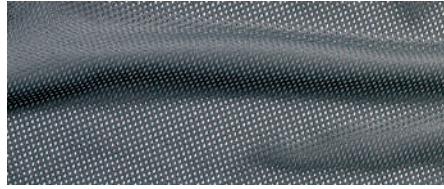

### Net

Used for bathing or showering.



### Spacer

A slightly elastic fabric that adapts to the user's body shape. Can be left in situ.\*\*

## Size guide

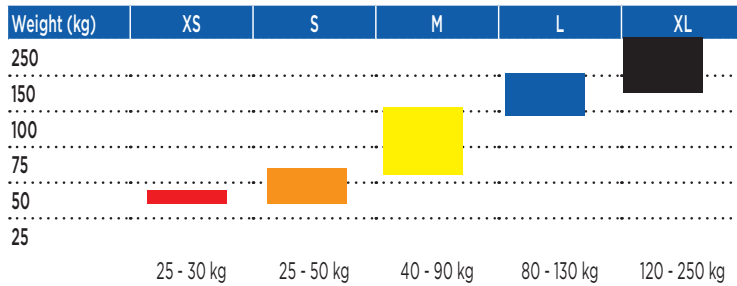

A risk assessment must be carried out prior to use of one manufacturer's sling on another manufacturer's hoist.

It is important to carry out a risk assessment with reference to skin integrity for those who be seated on a sling for long periods.

All slings should be tested and adjusted to the individual user to ensure optimal comfort and safety during transfers.

Sling Types	Fabric Matrix			Size Matrix				
	Solid	Net	Spacer	XS	S	M	L	XL
Universal Low	●				●	●	●	
Universal Standard	●	●	●		●	●	●	●
Universal High	●	●	●	●	●	●	●	●
Universal High Plus	●	●	●		●	●	●	● <sup>1</sup>
Dress Toileting	●				●	●	●	●
Dress Toileting High	●				●	●	●	●
Easy-fit	●		●	●	●	●	●	●
Amputee	●				●	●	●	●
Comfort		●	●	●	●	●	●	●
Comfort Toilet	●	●		●	●	●	●	●
Comfort Standard		●	●		●	●	●	●
Standing Transfer Vest	●			●	●	●	●	●
Stand Assist	●				●	●	●	●
Transfer Stand Assist	●				●	●	●	●

*1. Only Available in Solid Material*

## Technical Data

For more comprehensive pre-sales information about this product, including the product's user manual, please visit [www.invacare.ca](http://www.invacare.ca)



*Invacare Slings* are part of the Safe Patient Handling range.

**Slings**  
200 kg<sup>1</sup>  
XL sizes: 250 kg

1. Except for Standing transfer vest in combination with groin band: the safe working load is 159 kg.

Invacare Canada LP [www.invacare.ca](http://www.invacare.ca) (800) 668-5324  
570 Matheson Blvd. E., Unit 8, Mississauga, Ontario, L4Z 4G4 Canada. All rights reserved. Trademarks are identified by the symbols ™, and ®. All trademarks are owned by or licensed to Invacare Corporation unless otherwise noted. Specifications are subject to change without notification. © 2017 Form No. 18-378C



TRUSTED SOLUTIONS, PASSIONATE PEOPLE